



DOUBLETREE

BY HILTON™

WINSTON SALEM – UNIVERSITY



## SUCCESSFUL SETTINGS

The DoubleTree by Hilton brings the Arts of Winston Salem out of downtown and into the comforts of the Hotel. The modern lobby debuts an eclectic, new look that celebrates a style uniquely its own. Infusing the history of Winston Salem with it's energetic color pallet and contemporary furnishing.

The Hotel is designed with your comforts in mind. Workstations in the lobby will help you enjoy the atmosphere and company of other travelers when on the road. If socializing in the seating area is what you desire, there are easy access USB and power outlets to help you stay powered. Our wireless Internet can be used throughout the Hotel and is designed to keep you connected.

Share a table and American Cuisine at the Providence Restaurant, located off the lobby. Don't forget to unwind in your downtime, poolside in one of the cabanas or next to the fire pit with a glass of wine - the perfect finish to any day.



## SWEET TOOTH

There is something special about a warm, yummy chocolate chip cookie. It says “Welcome” in so many ways. That’s why we give one to every guest as they check in. It’s our way of showing you how much we care. We know it can be hard to have just one. Send friends, family, colleagues – or even yourself – a tin of 6 freshly Ready-to-Eat Cookies, and you can have the DoubleTree experience at home. Share the warmth!





## SCRIBE

We make it so that you don't have to sit in your guest suite all night. Working from one of our two workstations in the business center makes finishing any project a snap. Whether you are a PC or Mac user we've got you covered. If you are working with a colleague it's easy at the work station, located in the lobby. With seating for two it provides plenty of space for you to spread out while completing a project or holding an impromptu meeting.



If comfort is what you seek, then sit back in the seating area and plug into one of the many USB or power outlets with easy access. Even the most tech savvy business traveler will be able to stay connected and on track while on the road.



## SPLASH

Take in the sounds of nature and the fresh air at the DoubleTree by Hilton pool. Refresh your senses in our outdoor pool, featuring a poolside grill and fire pit. The pool deck is an ideal location to read a book or listen to music on one of our lounge chairs or in either of our two cabanas. The pool may be reserved for special events.

Why not make a splash for all of the right reasons. Our Chef will work with you on creating tasty shareable plates purveyed by our culinary team in a setting that is pre-SoCal Chic, illuminated by the ever-present Winston Salem star scape. Just expect rave reviews and happy high fives for your artful choice.



Pool: 800 SQ FT

Pool Deck: 3,200 SQ FT



## SAVORY BEGINNINGS

Providence Restaurant is the perfect retreat for a few moments away from the work place or a special dinner with family or friends. Providence is the antidote for the everyday dining experience, as you relax in our incredible cosmopolitan dining room. Our menus include locally sourced meats and produce.

Whether you join us for our daily breakfast buffet, step in for our Local Express Lunch, or share a special evening meal with us, Providence is the place to satisfy your hunger and support our mission.





## STANDOUT

Our Inspired Meetings team will provide personalized assistance when planning your next meeting or event. Our uniquely designed space offers countless opportunities for you to host your next event, including pre-function space perfect for drinks or a buffet service.





## STATE OF THE ART

The right technology makes a big impact on meetings and events. Our Hotel offers the industry's most extensive portfolio of conference room technology. Both dependable and state-of-the-art, from business-grade networking to leading-edge audio visual—we have what you need to keep attendees engaged and productive.

Our on-site, expert technology professionals are ready to support your specific requirements and answer any questions you may have.

- Wired and wireless fiber-optic Internet access
- Hi-definition LED television screens for presentations and media
- Polycom speaker phones for audio conferencing
- Video conferencing equipment with presentation sharing features
- Presentation equipment and projectors
- Wall and floor mounted display and audio ports for connectivity

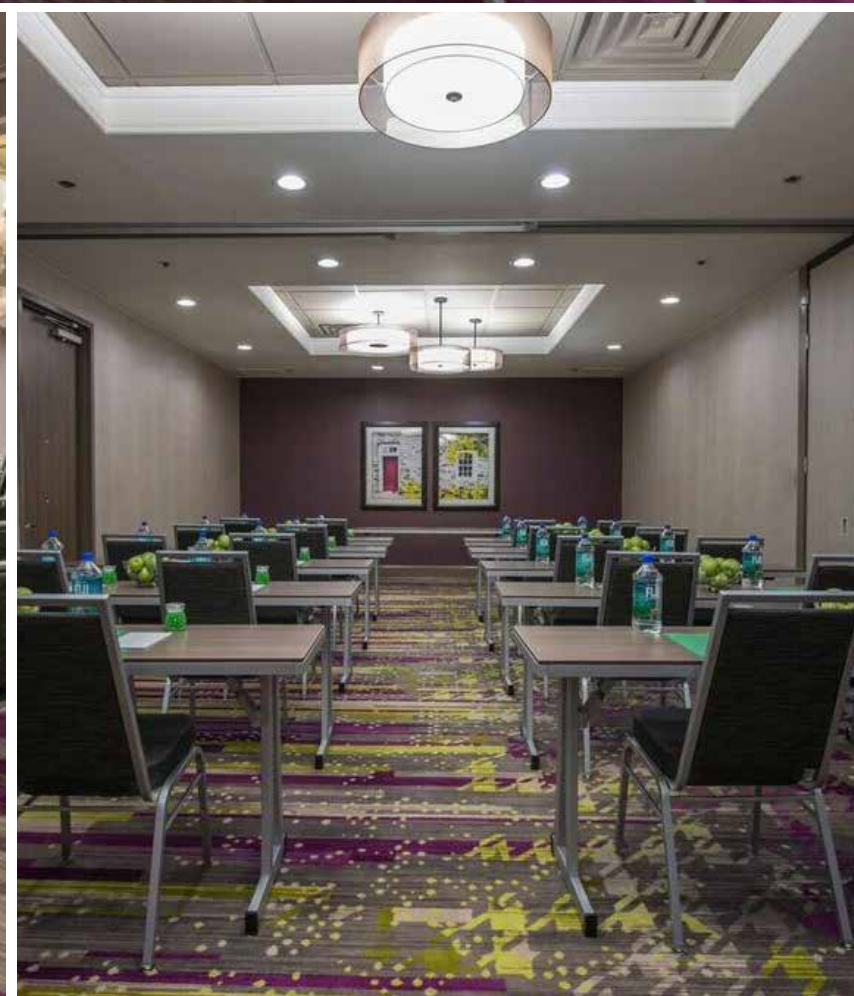



## SERENDIPITY A-B-C

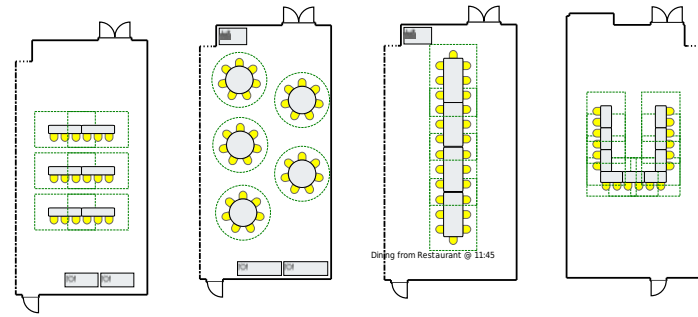

## SQUARE A-B

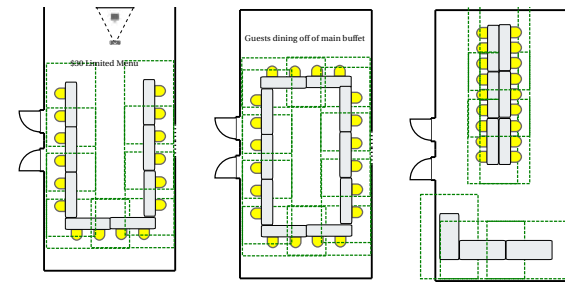

## SERENDIPITY BALLROOM

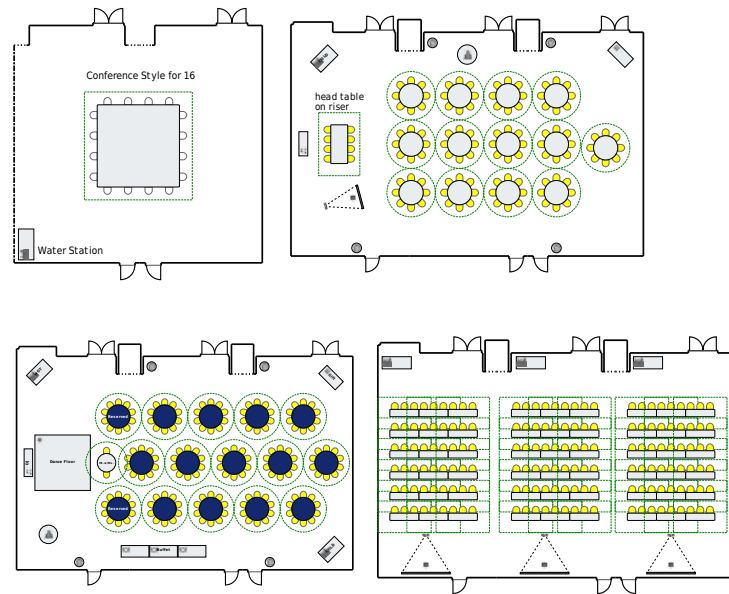

## SALEM

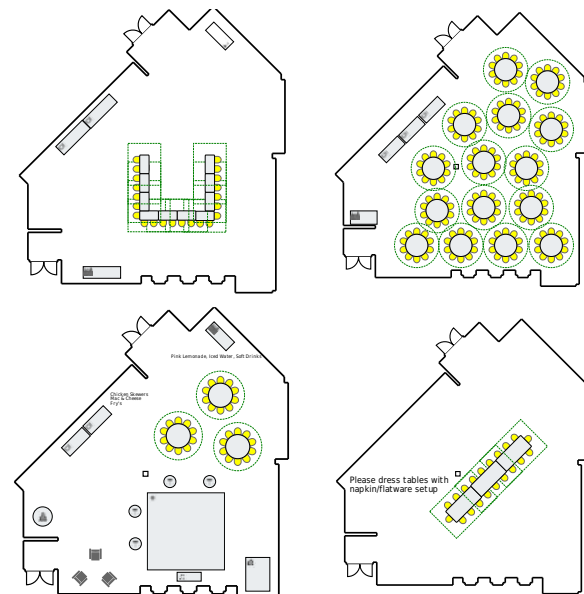

NAME OF ROOM	DIMENSIONS	TOTAL SQ. FT.	THEATRE	ROUNDS	CLASSROOM	RECEPTION
Serendipity Ballroom	69' x 45'	3,103	350	200	150	450
Serendipity A	25' x 45'	1,035	110	50	50	150
Serendipity B	23' x 45'	1,035	110	50	50	150
Serendipity C	23' x 45'	1,035	110	50	50	150
Square A/B	17' x 34'	578	50	40	30	50
Square A	17' x 17'	289	30	20	15	25
Square B	17' x 17'	289	30	20	15	25
Salem Room	46' x 45'	2,100	175	110	80	250
Situation	14' x 17'	238	-	-	-	-



## SCULPT

Don't let being on the road get you out of your routine. Sculpt fitness center is an excellent way to recharge your mental battery. With state-of-the-art Precor machines and an expanded free weight area including plenty of room for yoga, there are no excuses.





## SWEET DREAMS

Modern, chic, trendy - just a few words to describe your evening's retreat. With over seven USB ports to keep you connected, this room is perfect for today's travelers. If working from your room is in your plans the spacious work station will give you ample space to spread out, or catch your prime time shows on a 42" HD television.



- Sweet Dreams Sleep Experience
- 42" LED High Definition Televisions
- Clock Radios with MP3 Connection
- Mini Refrigerator
- USA Today Daily
- Keurig Coffee Maker
- Daily Laundry / Valet Services
- Multi-Lingual Staff
- Room Service
- In-Room Safes that accommodate Laptops
- 7+ USB Power Stations
- 300 Thread Count Sheets
- LED Bedside Reading Light
- Back-lit Bathroom Vanity

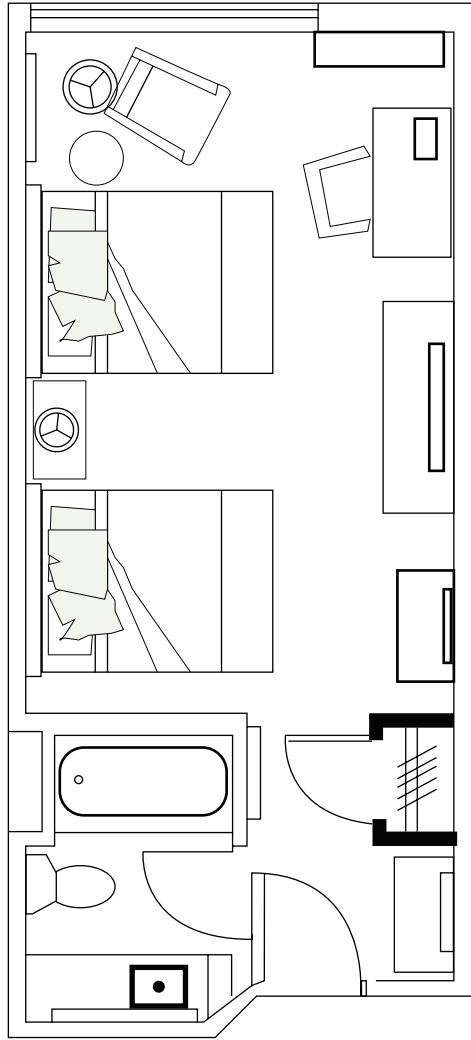

**STANDARD 2 QUEEN ROOM**

**340 SQ FT**

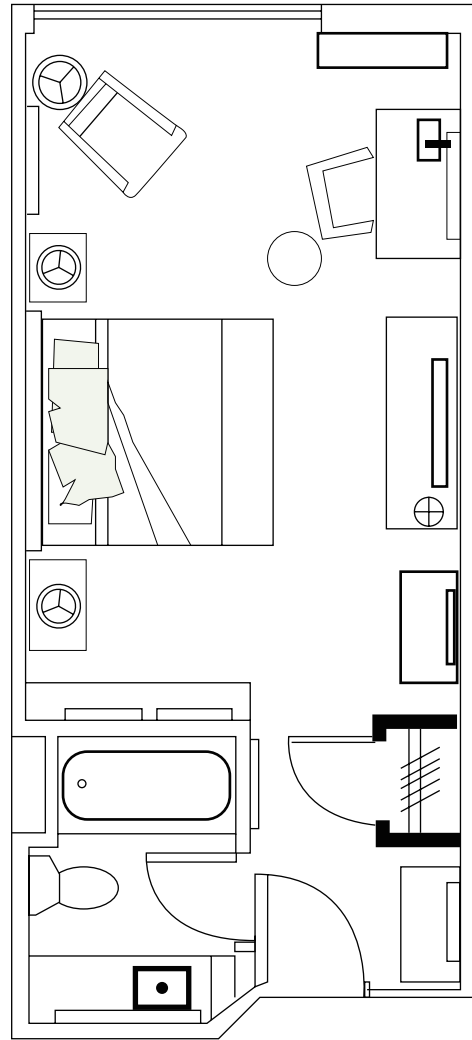

**STANDARD KING ROOM**

**340 SQ FT**

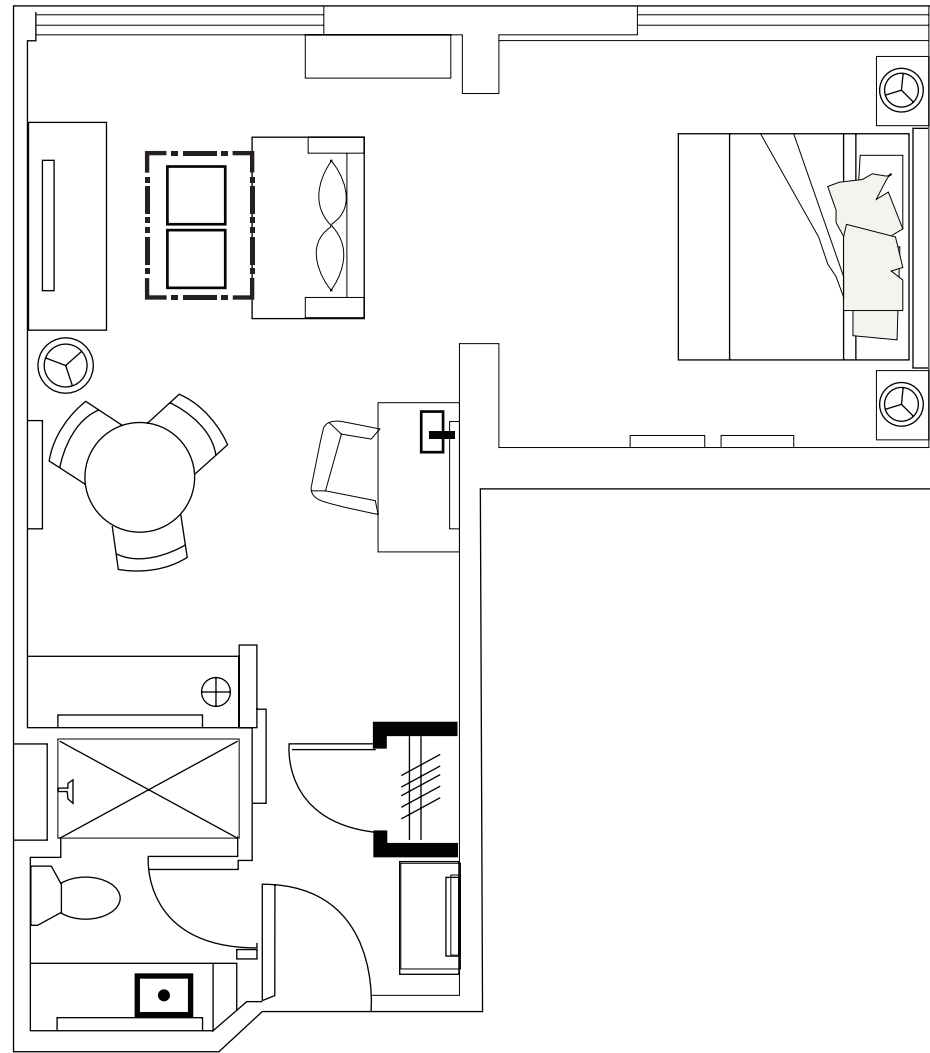

**STANDARD JUNIOR SUITE**

**510 SQ FT**

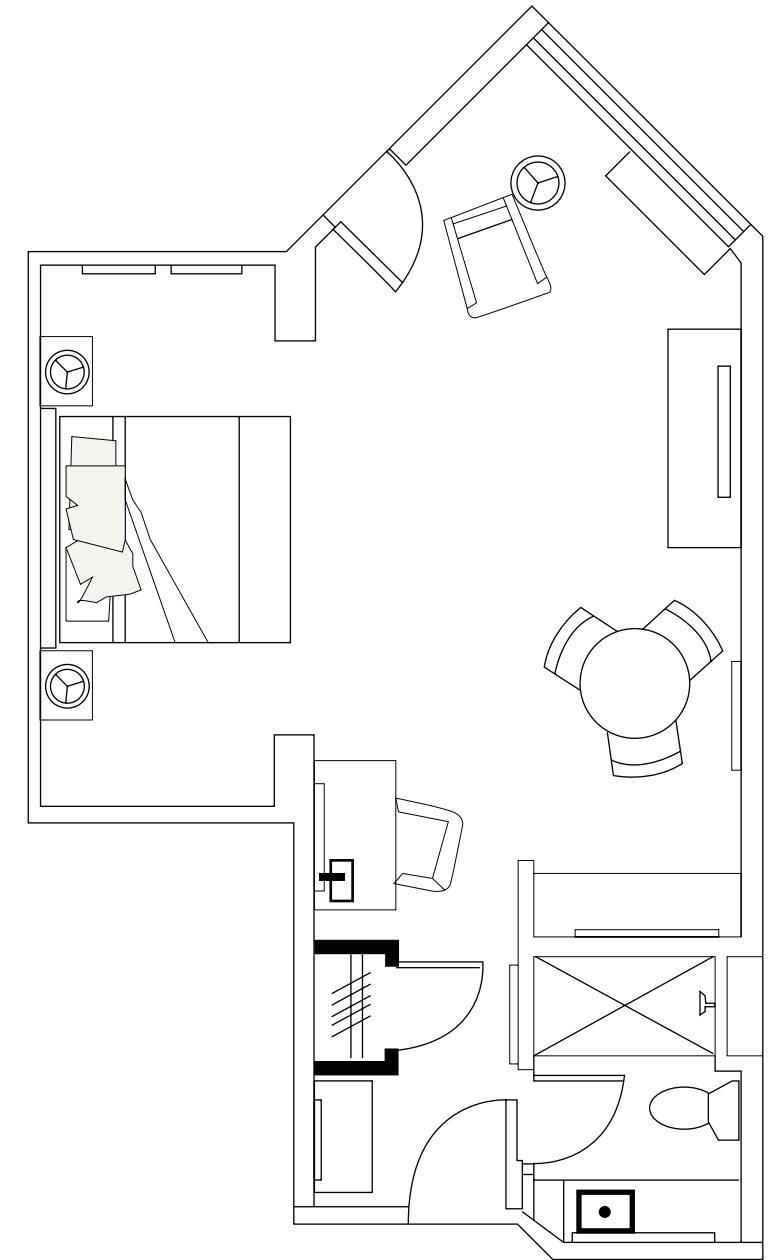

**KING DELUXE SUITE**

**460 SQ FT**



## SEE THE TOWN

### ATTRACTIONS

- Benton Convention Center
- Childress Vineyards
- Children's Museum of Winston Salem
- City Center
- Frank L. Horton Museum Center
- Hanes Mall
- Historic Bethabara Park
- Lawrence Joel Veterans Memorial Col
- Old Salem
- Old Salem Museums & Gardens
- Piedmont Craftsmen Shop
- Piedmont Triad Farmer's Market
- Reynolda House Museum of American Art
- SciWorks
- Westbend Vineyards
- West End Historic District
- Winston Salem Visitor Center

### BANKS

- NewBridge Bank
- First Citizens Bank
- Bank of North Carolina
- First Community Bank

### BANKS

- Fidelity Bank
- Piedmont Federal Savings Bank
- Woodforest National Bank
- Bank of America
- Wells Fargo Bank
- BB&T
- First Tennessee Bank
- Deutsche Bank
- Bank of the Ozarks
- Mechanics & Farmers Bank
- Winston Salem Federal Credit Union
- PNC Bank

### COLLEGES & UNIVERSITIES

- Forsyth Technical Community College
- Piedmont International University
- Salem College
- University of North Carolina School of the Arts
- Wake Forest University
- Winston Salem State University



## SEE THE TOWN

### COMPANIES

- Krispy Kreme Doughnuts
- R.J. Reynolds Tobacco Company
- TW Garner Food Company
- Branch Banking and Trust Company
- Hanes Brands Inc.
- Reynolda Manufacturing Solutions
- Southern Community Bank
- ISP Sports and Lowes Foods Stores
- Baptist Medical Center
- B E Aerospace, Inc.

### CHARGING STATION

- Central Park

### NIGHT LIFE

- Luna Lounge & Tiki Bar
- Old Winston Social Club
- Hoots Roller Bar & Beer Co
- Krankies
- Tate's Craft Cocktails
- West End Opera House

### SPORTING VENUES

- BB&T Ballpark
- Greensboro Coliseum
- Groves Stadium
- Lawrence Joel Veterans Memorial Coliseum
- Official Bowman Gray Stadium Racing
- Winston Salem Fairgrounds & Annex

### SHOPPING

- Hanes Mall
- H&M
- Banana Republic
- Anthropology
- Gap
- Express
- Talbots

### WINERIES

- Childress Vineyards
- Raffaldini Vineyards & Winery
- Roundpeak Vineyards
- Sanders Ridge



## SAMPLE THE LOCAL FLAVORS

- Atelier on Trade  
Desserts, Bakeries, Coffee & Tea  
533 N Trade St
- Black Mountain Chocolate Factory  
Desserts, Gelato, Bakeries  
732 N Trade St
- Di Lisio's  
Italian  
301 Brookstown Ave
- Fratelli's Italian Steakhouse  
Steakhouses, Italian  
2000 Reynolda Rd
- Kabobs On Fourth  
MiddleEastern  
214 W Fourth St
- HakkaChow  
Asian Fusion, Chinese, Sushi Bars  
615 St. George Square Ct
- Mooney's Mediterranean Cafe  
Mediterranean, Middle Eastern  
101 W 4th St
- 6th & Vine Wine Bar  
American, Wine Bars, Breakfast & Brunch  
209 W 6th St
- Thai Sawatdee  
Thai  
5232 Robinhood Village Dr
- The Honey Pot  
Southern, American  
285 W 4th St
- The Porch Kitchen and Cantina  
Tex-Mex, Coffee & Tea  
840 Mill Works
- The Tavern in Old Salem  
American  
736 S Main St

**SEE YOU SOON**

**DoubleTree by Hilton Hotel Winston Salem - University**

5790 University Parkway, Winston Salem, North Carolina, 27105  
TEL: +1-336-767-9595 FAX: +1-336-744-1888

[www.doubletree.com](http://www.doubletree.com)  
email: [gm\\_intwu@hilton.com](mailto:gm_intwu@hilton.com)